



ISO 13485:2016



ISO 9001:2015



INTERNATIONAL ACCREDITATION SERVICE™

Operating Surgical Tables

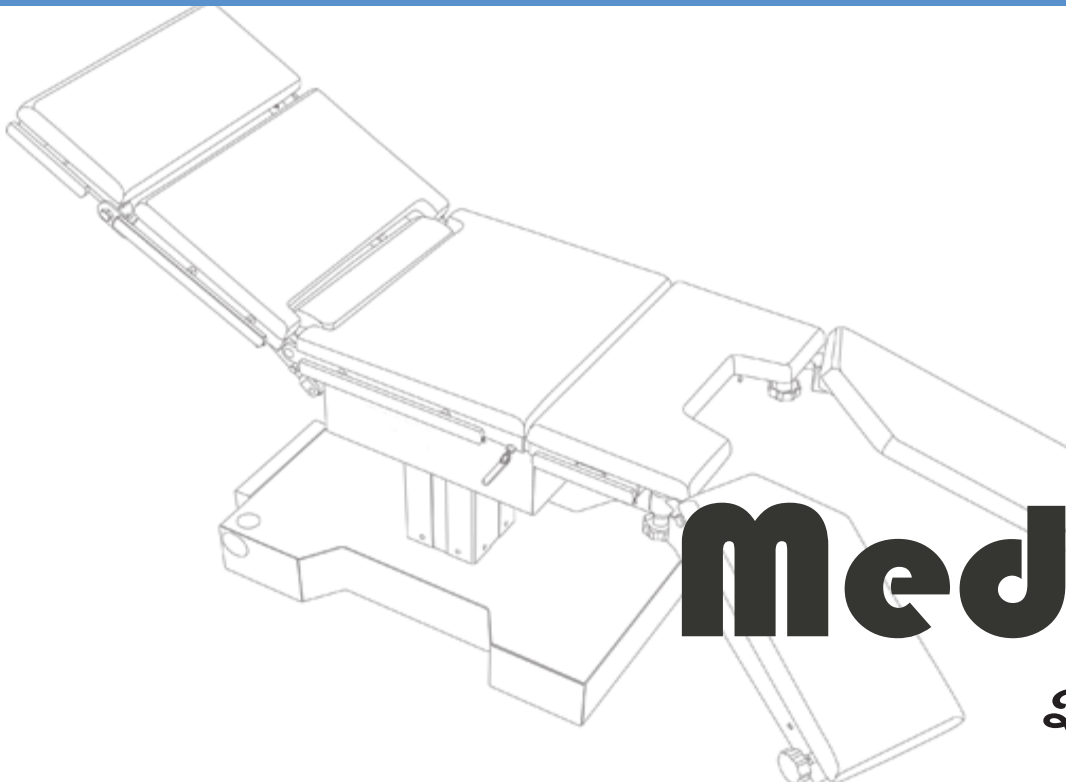

Medivion™

Quality Defined

MEDIVION® is one of the prominent ISO 9001:2008 & MSME Regd. Company, specializing in the production of Operation Theater Tables, LED Operation Theater Lights, & Medical Furniture in India, which is continued to be the trendsetter throughout the years of history. From the last 8 years, we have created a proficient niche both in the domestic medical industry. We have the privilege to design and distribute the most sophisticated and technological latest products in the service of medical profession. Our Research and Development department is continuously involved in designing & developing better design and technical solution at the required standard by the customers. We are empowered with an efficient workforce of skilled and dedicated staff. Our manufacturing facilities are located in Kolkata & Haryana, equipped with the latest machinery and all the work is done in house. While continuously increasing the production process, we also continuously improve the product quality. We assure to satisfy you with our quality, workmanship and after sales service as we always do to meet the requests of our valuable customers. We give our customers a tailor made cost for cost effectiveness by keeping close watch at every step in order to give a personalized service. We can also manufacture the equipments according to your required specification as we are the original manufacturers, so please let us know if you need any change. MEDIVION® team is looking forward to sincere cooperation with you. Lets advance and pursue a wonderful future by mutual efforts.

Certificate of Registration
This is to Certify that
Quality Management System of
MEDITECH SYSTEMS (INDIA)
265, ROY BAHADUR ROAD, KOLKATA - 700 053,
WEST BENGAL, INDIA

has been assessed and found to conform to the requirements of
ISO 9001:2015
for the following scope:
MANUFACTURER OF MEDICAL BEDS, HOSPITAL FURNITURE,
OPERATION THEATRE TABLES, OPERATION THEATRE
LIGHTS, MEDICAL EQUIPMENT

Certificate No. 1800BIB04
Initial Registration Date: 05/03/2018
Date of Expiry: 04/03/2021
1st Surve. Due: 05/02/2019
Issuance Date: 05/03/2018
2nd Surve. Due: 05/02/2020

Director
AQC MIDDLE EAST FZE

ISO 9001:2015
ACCREDITED
CERTIFICATION
9000-139

IAF
INTERNATIONAL
ACCREDITED
FORUM

Certificate of Registration
This is to certify that the
MEDITECH SYSTEMS (INDIA)
265, Roy Bahadur Road, Kolkata - 700053, West Bengal, India
Has been assessed by QCAS and found to
comply with the requirements of
ISO 13485:2016
Quality Management System for Medical Devices

For the following scope:
MANUFACTURER OF MEDICAL BEDS, HOSPITAL FURNITURE, OPERATION THEATRE
TABLES, OPERATION THEATRE LIGHTS, ELECTRO-MEDICAL DEVICES, ANAESTHESIA
APPARATUS, VERTICAL STERILIZERS, HORIZONTAL STERILIZERS, SURGICAL
INSTRUMENTS, LAPAROSCOPY INSTRUMENTS, ELECTRO-SURGICAL GENERATORS.

Certificate No. :- QCAS-2019-MSIA-29608

To verify this certificate please visit at www.gcafas.com

Date of Certification: 20 September 2019
1st Surveillance Date: 19 September 2020
2nd Surveillance Date: 19 September 2021
Re-certification Date: 19 September 2022

Authorised Signatory

QCAS

Certificate of Compliance
We hereby declare that the technical file of product Complied with the requirement of
the directives Medical Council directive '93/42/EEC of June 1993

Manufacturer
Name : **MEDITECH SYSTEMS (INDIA)**
Address : 265, Roy Bahadur Road, Kolkata - 700053, West Bengal, India

Product : MEDICAL BEDS, HOSPITAL FURNITURE, OPERATION THEATRE TABLES, OPERATION THEATRE
LIGHTS, ELECTRO-MEDICAL DEVICES, ANAESTHESIA APPARATUS, VERTICAL STERILIZERS,
HORIZONTAL STERILIZERS, SURGICAL INSTRUMENTS, LAPAROSCOPY INSTRUMENTS,
ELECTRO-SURGICAL GENERATORS.

The Certification Body has performed an audit of the above product quality system covering that
design, Manufacture and final inspection of the certified product. The quality system has been
assessed, approved and is subject to continuous surveillance according to the
Medical Council directive '93/42/EEC of June 1993

This Certificate is issued under the following conditions:
1. It applies only to the factory system maintained in the manufacture of above referenced models
and it does not substitute the design or type examination procedures, if required.
2. The certificate remains valid until the manufacturing conditions or the quality system are changed.
3. The certificate Validity is conditional by positive results of surveillance audits.
4. After fulfilling the relevant legislation, the manufacturer shall affix to each device of the
above referenced models.
5. The CE mark as shown above can be used, under the responsibility of the manufacturer, after
completion of an EC Declaration of conformity and compliance with all relevant EC Directives.
The statement is based on a single evaluation of one sample of above mentioned product. It does
not imply an assessment of the whole production.

Validity of this certificate can be verified at www.gcafas.com

Certificate No. :- QCAS-2019-MSIA-1059

Date of Certification: 20 September 2019
1st Surveillance Date: 19 September 2020
2nd Surveillance Date: 19 September 2021
Date of Expiry: 19 September 2022

(Subject to the company maintaining its system to the required standard)

Authorised Signatory

CE

QCAS

Certificate of Compliance
This is to certify that
MEDITECH SYSTEMS (INDIA)
at
265, Roy Bahadur Road, Kolkata - 700053, West Bengal, India
Has been assessed and found working satisfactorily as per the norms of
"Good Manufacturing Practice"
as laid down by World Health Organization
Good Manufacturing Practice (GMP) System

For the following scope:
MANUFACTURER OF MEDICAL BEDS, HOSPITAL FURNITURE, OPERATION THEATRE
TABLES, OPERATION THEATRE LIGHTS, ELECTRO-MEDICAL DEVICES, ANAESTHESIA
APPARATUS, VERTICAL STERILIZERS, HORIZONTAL STERILIZERS, SURGICAL
INSTRUMENTS, LAPAROSCOPY INSTRUMENTS, ELECTRO-SURGICAL GENERATORS.

Certificate No. :- QCAS-2019-MSIA-1060

To verify this certificate please visit at www.gcafas.com

Date of Certification: 20 September 2019
Issuance Date: 20 September 2019
1st Surveillance Date: 19 September 2020
2nd Surveillance Due: 19 September 2021
Re-Certificate Due: 19 September 2022

Authorised Signatory

GMP

QCAS

Sl. No.	Particulars	Remarks
1	1. Aadhar Number	9922228916
2	2. PAN Number	99UPT989818
3	3. Name of Entrepreneur	GENPRA, PATRA
4	4. Social Category of Entrepreneur	GENERAL
5	5. Gender	Male
6	6. Presently Handicapped	No
7	7. Name of Entrepreneur	MEDITECH SYSTEMS (INDIA)
8	8. Type of Organization	Proprietary
9	9. Location of Plant/Units	
10	10. IAF Registration No.	Name of Provision/Building/Village
11	11. Date of commencement	265, ROY BAHADUR ROAD, KOLKATA
12	12. Previous Registration details if any	District: WEST BENGAL, PIN: 700053
13	13. Bank Details	Branch: KOLKATA, State: WEST BENGAL, PIN: 700053
14	14. Major Activity	MS Code: 3399912193
15	15. Other	MS Code: 3399912193
16	16. Other	MS Code: 3399912193
17	17. Other	MS Code: 3399912193
18	18. Investment (Plant & Machinery/Equipment)	100% IN LAKHS
19	19. Annual Industry Credit	100% IN LAKHS

Declarations:
I/We declare that information given above is true to the best of my knowledge. Any information, that may be required to be verified, shall be provided immediately before the concerned authority.
Signature/Mobile No. of the person is available now for download: <https://www.gcafas.com/verify/MSIA/29608>

Electric Operating Table (Advance)

MSI-1001E

C-Arm Compatible

Mobile
Sliding Top



Side Control Panel (Optional)

Technical Data

Overall Length of the table	1950 mm
Overall Width of the table	530 mm.
Minimum height of the table	780 mm
Maximum height of the table	1080 mm
Trendlenburg/Reverse	40 degree
Flex/reflex	80degree/220degree
Side Tilt	22degree
Kidney Section	125mm manually
Leg plate	90 degree down
Back Plate Up/Down	80° / 25°
Leg Split	180°
Head Plate Up/Down	60° / 20°
Power Input	220V/50Hz

Standard Positions

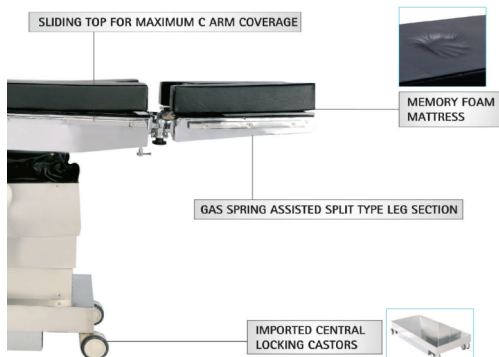
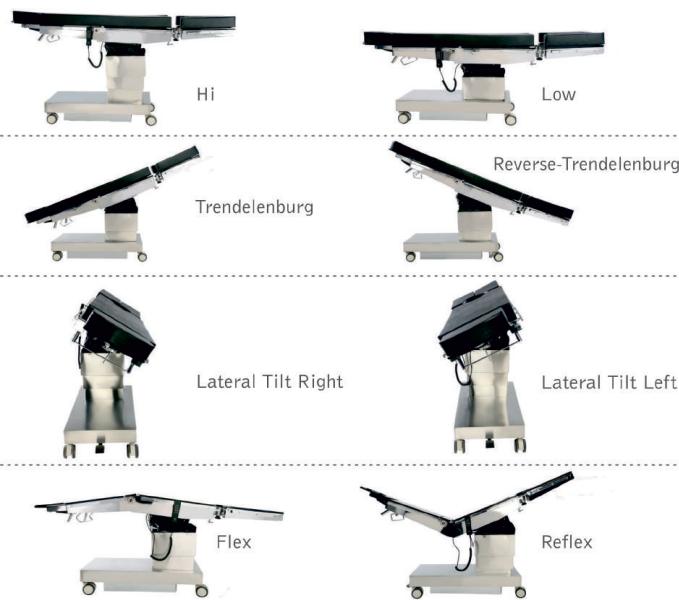

LITHOTOMY POSITION



SPLIT TYPE LEG SECTION



Salient Features

GAS SPRING ASSISTED
DETACHABLE HEAD SECTION

GAS SPRING
ASSISTED BACK REST

COMPLETE TABLE IN
304G STAINLESS STEEL

IMPORTED MOTORS 4 FUNCTION

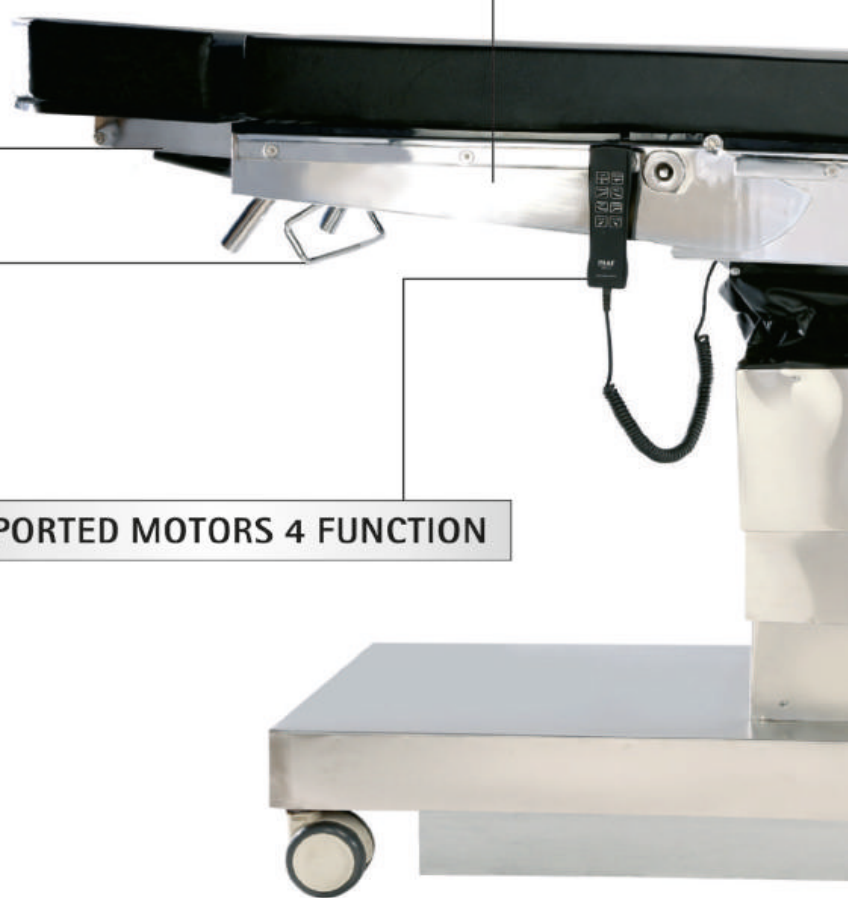

CHAIR POSITION



MAXIMUM SPACE FOR C ARM UTILISATION



Electro Manual Operating Table

C-Arm Compatible

MSI-2001ME

Sliding Top(Optional)



Salient Features

- 100% life saving due to low voltage electricity supply
- Offline battery backup upto 1hr.
- 180 kg weight capacity
- Full table function, articulation capability
- Full body imaging without special accessories
- Durable one touch pendant control
- Casters locable with single action brake
- Fully stainless steel 304 grade accuracy
- Electrical and mechanically operated height, trendelbar / reverse, lateral tilt and sliding top.

Technical Data

Overall Length of the table	1950 mm
Overall Width of the table	530 mm.
Minimum height of the table	780 mm
Maximum height of the table	1080 mm
Trendlenburg/Reverse	40 degree
Flex/reflex	80degree/220degree
Side Tilt	22degree
Kidney Section	125mm manually
Leg plate	90 degree down

Five Section Mattress	1 Set
Anesthetist screen	1 Nos.
Padded Shoulder Support	2 Nos.
Padded Lateral Support	2 Nos.
Padded Lithotomic Crutches	2Nos.
Padded Arm Rest	2Nos.
Drive Handle	1 Nos.



Chair Position



Remote



Extra Control Panel



Leg Split (Optional)

Electric Operating Table

C-Arm Compatible

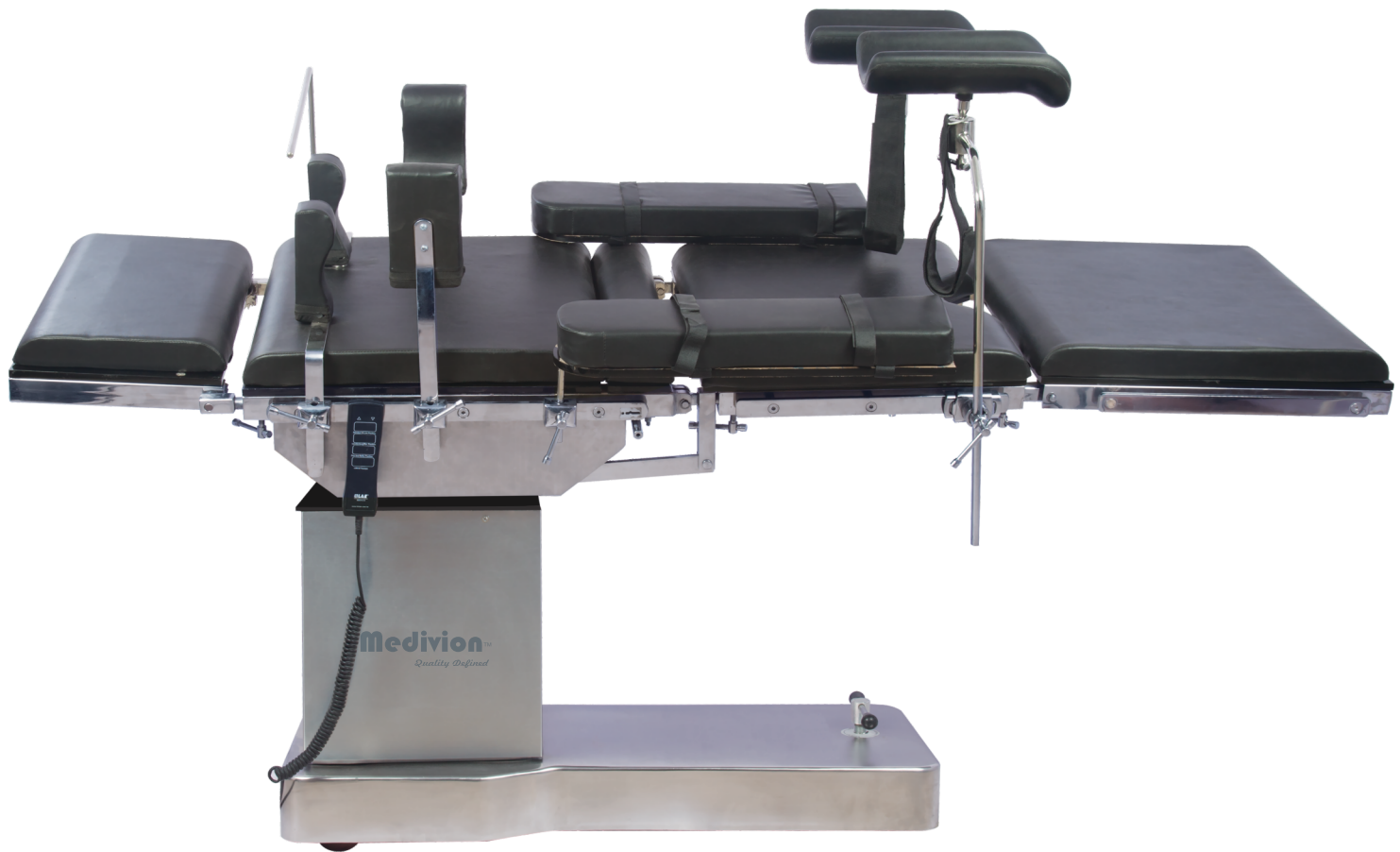

Salient Features

Five Section table top allow ease and comfort for positions.
 Radio-translucent top provides easy convenience for x-ray procedures.
 Eccentric pillar to ensure maximum coverage of C-Arm machine.
 Interchangeable Head & Leg Section.
 Base & Column covered with 304 Grade Stainless Steel top to ensure high durability & hygiene for the Operation room.

Five Section Mattress	1 Set
Anesthetist screen	1 Nos.
Padded Shoulder Support	2 Nos.
Padded Lateral Support	2 Nos.
Padded Lithotomic Crutches	2Nos.
Padded Arm Rest	2Nos.
Drive Handle	1 Nos.



Side Control Panel (Optional)

Salient Features

Electric Operation tables are designed keeping in view the needs of modern surgery procedures these tables are versatile & heavy duty enough to cater to all kind of modern surgeries.



Mechanical Movement



Technical Data

Overall Length of the table	1950 mm
Overall Width of the table	530 mm.
Minimum height of the table	780 mm
Maximum height of the table	1080 mm
Trendelenburg/Reverse	40 degree
Flex/reflex	80degree/220degree
Side Tilt	22degree
Kidney Section	125mm manually
Leg plate	90 degree down

Electrical Movement



Table Top



Trendelenburg



Anti-Trendelenburg



Flex



Re-Flex



Lateral Tilt Left



Lateral Tilt Right

Hydraulic Operating Table

C-Arm Compatible

MSI-4001H

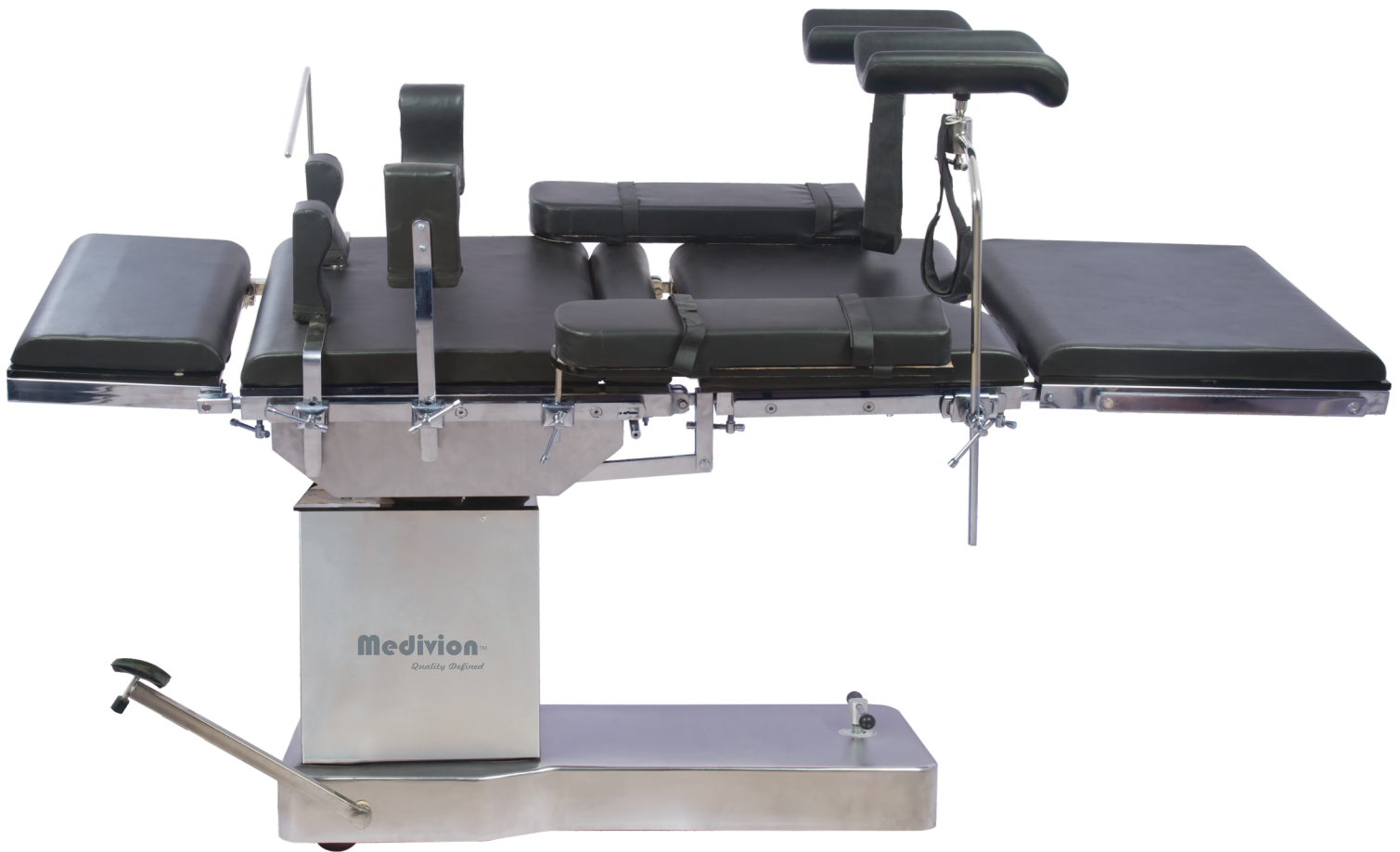

MEDIVION Hydraulic Operating tables are designed keeping in mind the needs of modern surgical procedures. These tables are versatile and heavy duty enough to cater all kind of modern surgeries. The table is adjusted with heavy duty concealed pump covered in stainless for long span of hydraulic.

Salient Features

Five Section table top allow ease and comfort for positions.

Radio-translucent top provides easy convenience for x-ray procedures.

Eccentric pillar to ensure maximum coverage of C-Arm machine.

Interchangeable Head & leg Section.

Base & column covered with 304 Grade Stainless Steel top to ensure high durability & hygiene for the Operation room

Durable heavy duty leak proof concealed pump.

Heavy duty smooth gear mechanism to avail all operating position.

55mm thick water proof mattress.

Hydraulic Operating Table

Standard Accessories

MSI-4001H

Technical Data

Overall Length of the table	1950mm
Overall Width of the table	530mm.
Minimum height of the table	780mm
Maximum height of the table	1030mm
Trendlenburg/Reverse	30 degree
Flex/reflex	80degree/220degree
Side Tilt	22degree
Kidney Section	125mm manually
Leg plate	90 degree down
Hi-Low Lift	Hydraulic

Standard Accessories

Five Section Mattress	1 Set
Anesthetist screen	1 Nos.
Padded Shoulder Support	2 Nos.
Padded Lateral Support	2 Nos.
Padded Lithotomic Crutches	2Nos.
Padded Arm Rest	2Nos.
Drive Handle	1 Nos.

Optional Accessories

Universal Orthopedic Attachment

S.S. Instrument Tray With Hanger

S.S Urology Tray

Neuro Surgery Attachment

Arm Surgery Attachment

Semi Electric Operating Table

C-Arm Compatible

MSI-4002SE

Standard Accessories

1. Five Sections Mattress : 1 set.
2. Anesthetist Screen : 1 pcs.
3. Padded Shoulder Support : 2 pcs.
4. Padded Lateral Support : 2 pcs.
5. Padded Lithotomy Crutches : 2 pcs.
6. Padded Arm Rest : 2 pcs.



Hydraulic Operating Table

MSI-5001H

Super Delux



Salient Features

- Hydraulic & Mechanically Operated
- Stainless Fitting
- Detachable, head, leg & Pelvic section
- In built kidney bridge
- Five Sectional Stainless Steel Top
- Base & Cover made of attractive, east to clean Stainless Steel.
- Smooth Patient Positioning

Optional



Technical Data

Overall Length of the table	1950mm
Overall Width of the table	530mm.
Minimum height of the table	780mm
Maximum height of the table	1030mm
Trendlenburg/Reverse	30 degree
Flex/reflex	80degree/220degree
Side Tilt	22degree
Kidney Section	125mm manually
Leg plate	90 degree down
Hi-Low Lift	Hydraulic

Standard Accessories

Five Section Mattress	1 Set
Anesthetist screen	1 Nos.
Padded Shoulder Support	2 Nos.
Padded Lateral Support	2 Nos.
Padded Lithotomic Crutches	2Nos.
Padded Arm Rest	2Nos.
Drive Handle	1 Nos.



Ortho Attachment allows the table to be used for the lower extremity procedures. Available at competitive prices our ortho attachment is purely made of stainless steel which resist corrosion.

Salient Feature

The Orthopedic Attachment can be used with any operating table. In addition, a pelvic support plate is supported on top of the frame and is formed with an asymmetrical construction.

Stirring Instruments allows flexion/raising of legs & stirring/string ball joints locked from foot end. Two traction devices on sliding spot with ball joint allowing flexions & rotations of foot with traction shoe with metallic sole.

Padded orthopedic knee crutches/provides support to the legs of the patient

Standard Accessories

Orthopedic Section	1 Nos.
Pelvic rest in 2 sizes	1 Nos. each
Pelvic support (Radio Translucent)	1 Nos.
Inner thigh support (Radio Translucent)	1 Nos.
Foot plat with Ortho Shoes	1 pair
Tibia Attachment	1 Nos.
Head Surgery table (Radio Translucent)	1 Nos.
Steinman pin Holding Clamp	1 Nos.
Head Rest for shoulder Surgery	1 Nos.
Leg Holder (Goepel Type)	1 pair

Optional Accessories



Spinal Attachment (Optional)



Hand Surgery



Horse Shoe Shape Cervical Attachment



Three Pin Head Mayfield Neuro Attachment

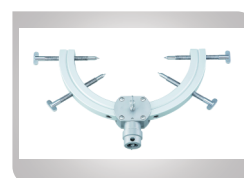

Sujita Head Fixator for Sitting/Prone Position

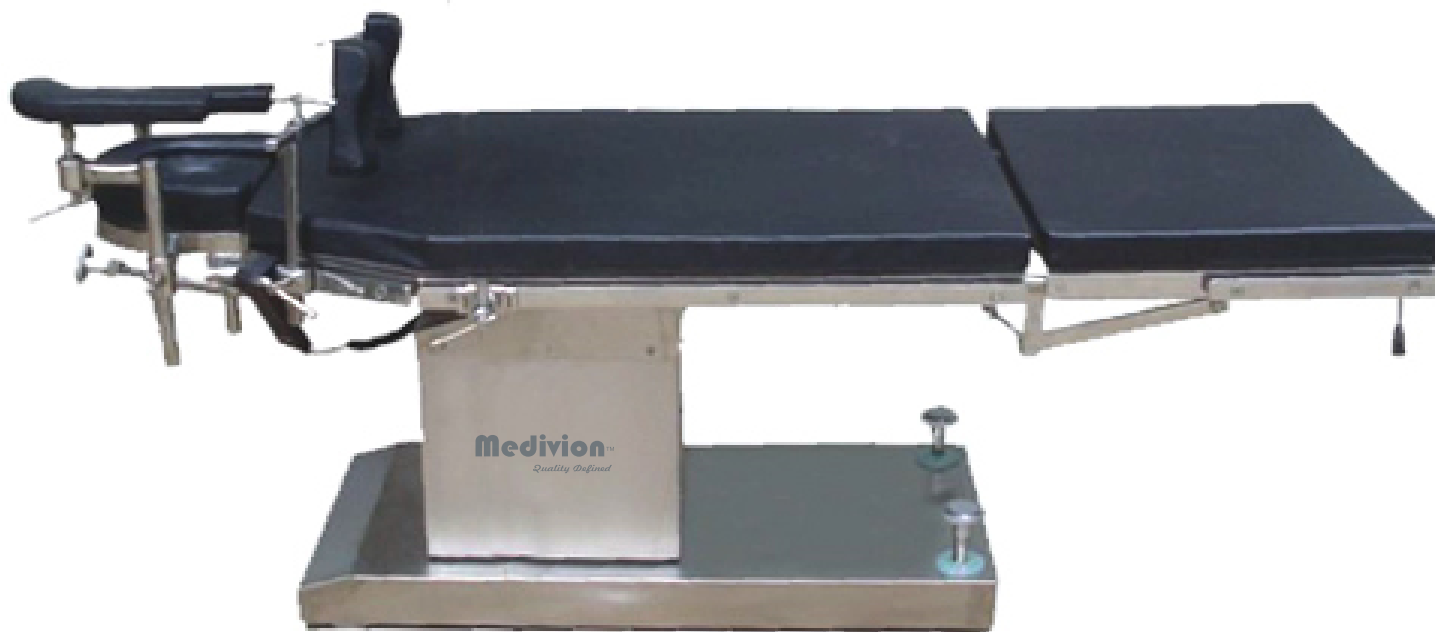

This Ophthalmic Table is specially designed for Ophthalmic surgery. Three sectional table is provided with drainage system in the head section. The table has sturdy base, column made up of stainless steel, antibacterial and is easy to clean. Electromotive height and trendelenburg positions with the help of lightweight handheld control unit.

Technical Data

Length of the Table	1900mm
Width of the Table Top	520mm
Minimum Height Without Mattress	Min 750mm
Maximum Height Without Mattress	Max 1000mm
Trendelenburg	25°
Reverse Trendelenburg	25°
Leg Section	0° - 90°

Salient Features

This Ophthalmic Table is specially designed for Ophthalmic surgery. Three sectional table is provided with drainage system in the head section. The table has sturdy base, column made up of stainless steel, antibacterial and is easy to clean. Electromotive height and trendelenburg positions with the help of lightweight handheld control unit. Eccentric Pillars Stainless Fitting Detachable, head & leg section Three Sectional Radio-Translucent Top Base & Cover made of attractive, easy to clean Stainless Steel Sophisticated mechanics provide smooth, step less articulation of the table top for precise patient positioning

Electric



Foot Switch (Optional)

Awesome Design

Durable, lightweight and easy to use hand control with ergonomic shape featuring easy-to read hand control pictograms.

Fully Laminated Mattress

MOULDED WATERPROOF SEALED BELLOW protects against infiltration of body fluids.

Easy To Use

Minimum Height upto 60 cm provides easy access for lady surgeon.

High Quality Mattress

A high quality 3 inches mattress enhances the adaptive capacity of the mattress.

Salient Features

Functional and versatile

Flexibility and precision

Hygienic design

Easy cleaning

User - friendly

Technical Data

Length of the Table	1600mm
Width of the Table Top	550mm
Minimum Height Without Mattress	Min 750mm
Maximum Height Without Mattress	Max 1000mm
Lateral Tilt	±20°
Back Section	±80°
Leg Section	0° - 90°
Floor Locking System	Manual

Gynecological/Obstetrics O.T. Table

MSI-8001E

Gynecological Attachments

Examination And Birthing Positions



Easy Insertion of Drainage Basin



Hand Grip Can Be Adjusted



Easily Fixable Mattress



Improved Universal Clamp

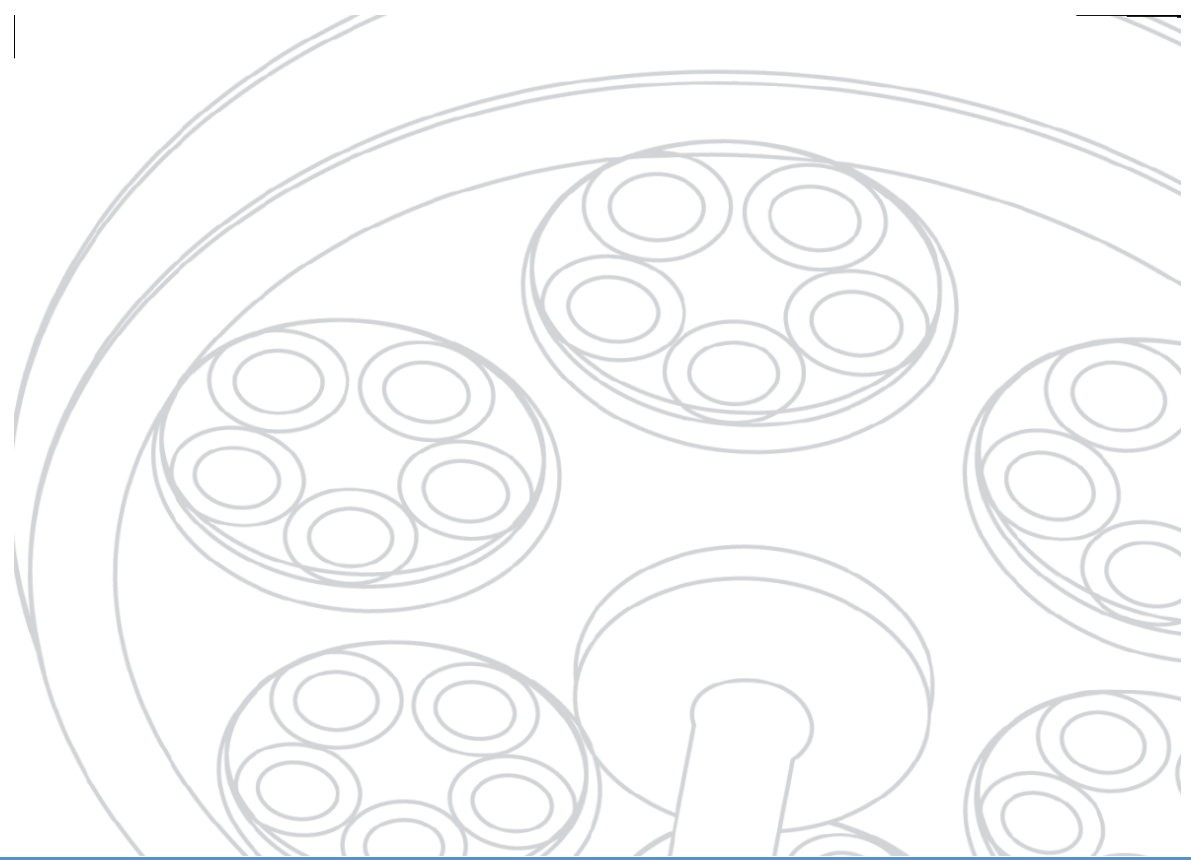

Proud To Make In India....

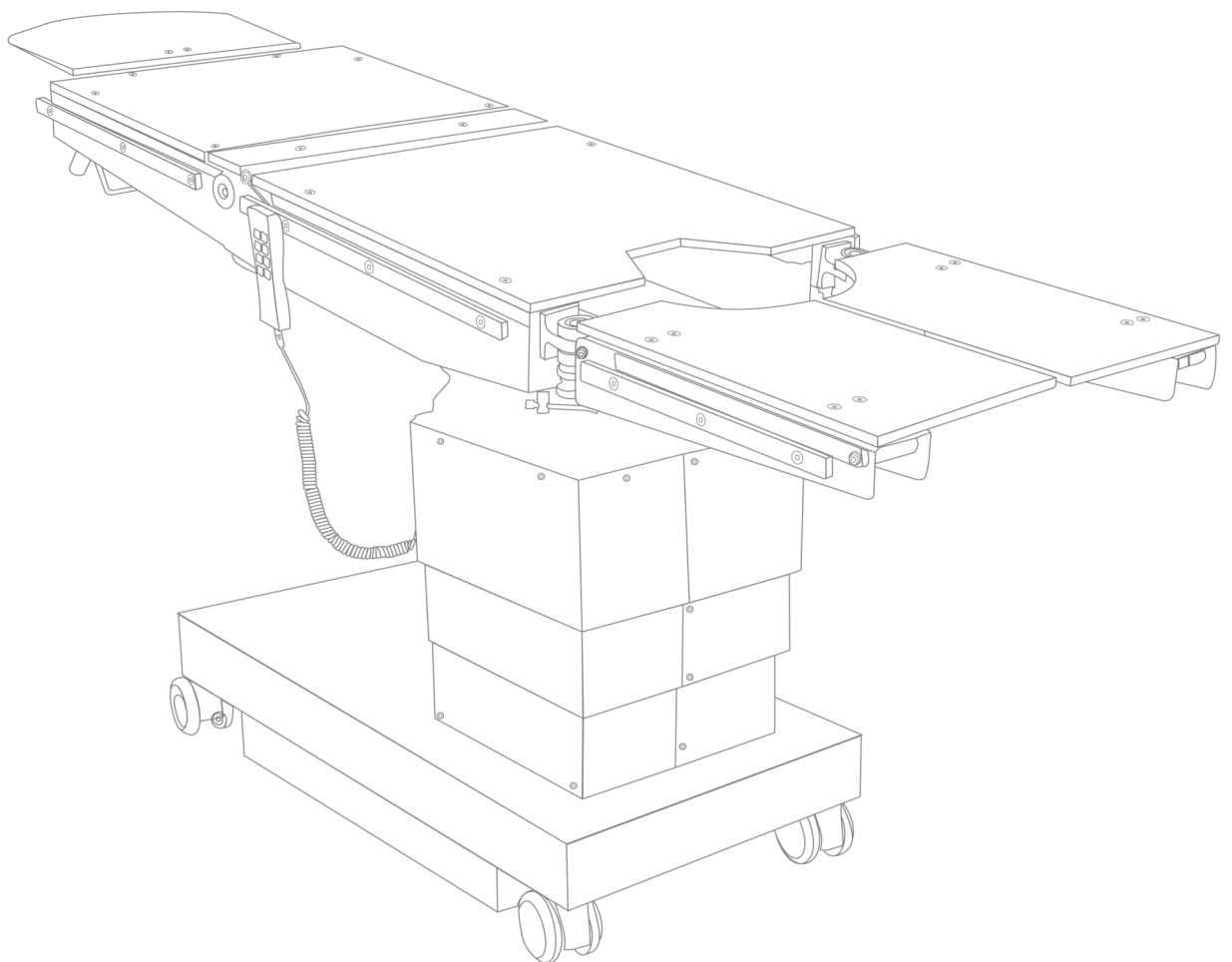

OUR OTHER RANGE OF PRODUCTS



Surgical LED O.T. Lights- Single Dome, Double Dome, Mobile.
Examination LED O.T. Lights.



Manufactured By:

Meditech Systems(India)

Regd. WorkShop & Office: 265, Roy Bahadur Road,

Kolkata - 700 053, WestBengal, India

Mobile: 9836096417/9830436926

Office: 033 2403 0094

email: meditechsystemsindia01@gmail.com

info.meditech01@gmail.com

www.indiamart.com/meditechsystemsindia

www.medivion.co.in

Authorised Distributor/Dealer

